

## 500W 水冷高電力抵抗器

500W WATER COOLING NON-INDUCTIVE  
HIGH POWER RESISTORS

RPH500

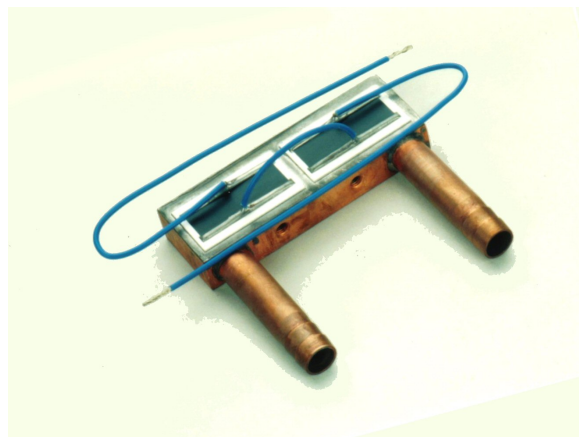

## 特長 用途

動作中の抵抗器の温度が極めて低い小型500W水冷抵抗器。平板無誘導抵抗体とツイストペア用のリード線と特殊な端子構造（特許）で構成した抵抗器。

広帯域の高周波特性によって優れたサージ吸収性能を發揮。

抵抗体は水冷筐体から高純度アルミナ基板で絶縁され、5KVの耐電圧を保証。

リード線の種類、長さ、端末処理、水口形状は、任意のご要望に応じることができます。

電力変換逆変換システム、産業用機器の電源、高出力ACモータ制御機器のサイリスタ、IGBTなどのスナバ抵抗器。

## Features and Applications

Small sized 500W water-cooled non-inductive resistor with a very low resistor temperature under operation. Flat plate resistance and twisted pair leads and special terminal structure (patent) are shown excellent surge absorption performances.

Resistors are insulated from case by the high purity alumina substrate, and are guaranteed to voltage-proof of 5kV.

Leads type, length, terminal processing (patented), and hose connection can be accepted arbitrary demands.

Surge suppression resistors for power thyristor and IGBT, used in power supply of electric power conversion system and of industrial apparatus, high output AC motor controls.

## 外形寸法 Dimensions (mm)

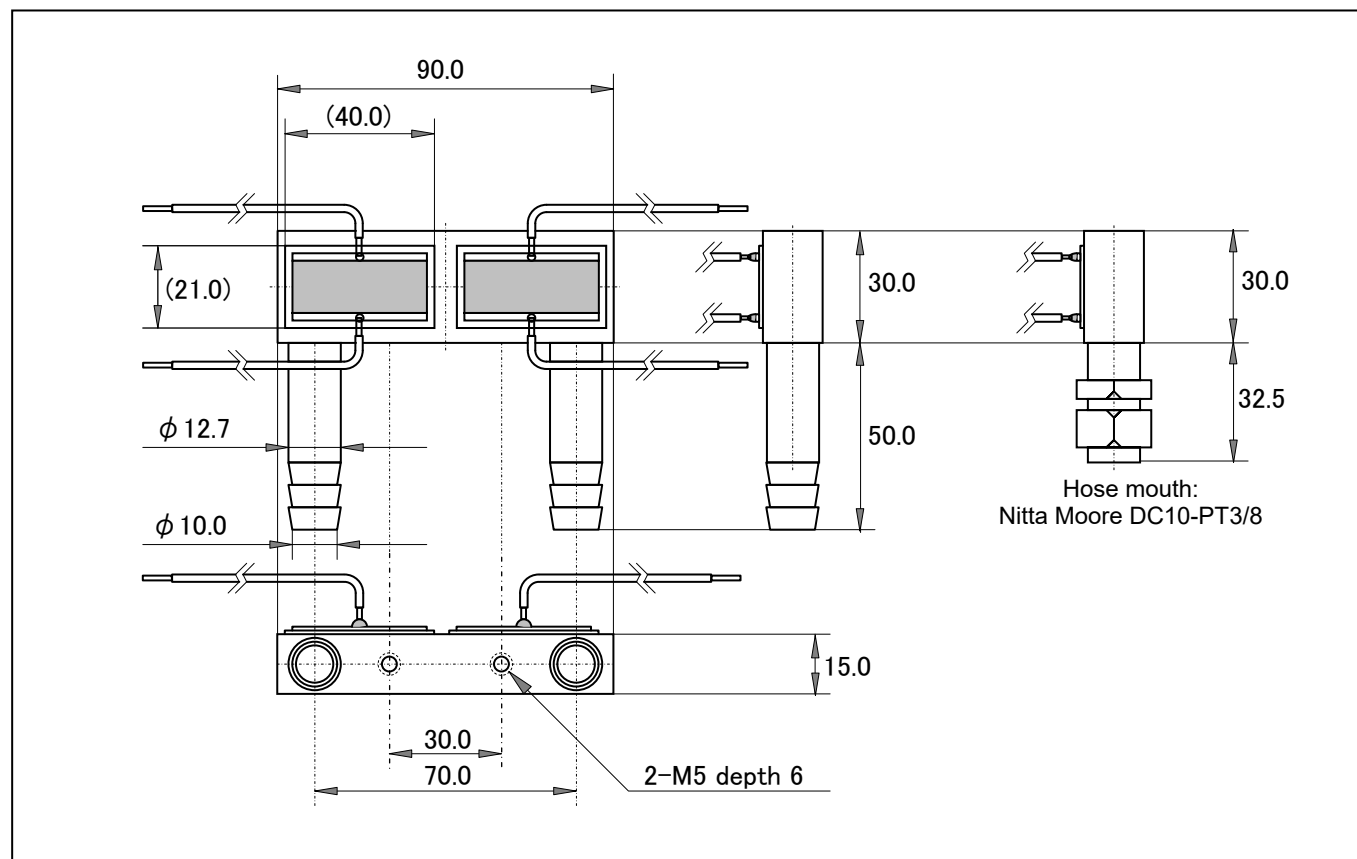

# POWER - NIKKOHM

## 500W水冷高電力抵抗器

500W WATER COOLING NON-INDUCTIVE HIGH POWER RESISTORS

RPH500

### 仕様性能 Specifications and Performances

		Specifications
公称抵抗値	Resistance	Any Value (odd value will be under MOQ 100pcs)
製作抵抗値範囲	Resistance Range	0.1Ω-1KΩ
抵抗温度係数	TCR	+/-250ppm/ °CC
抵抗値許容差	Tolerance	+/-10%
等価直列インダクタンス	Series Inductance	40nH/dual resistor, (Typical)
等価並列キャパシタンス	Parallel Capacitance	160pF/dual resistor, (Typical)
ホース継手	Hose Mouth	Standard: Nipple, any types are available.
冷却水温度	Water Temperature	+41°C maximum at inlet, more than the dew point
冷却水量	Volume of Water Flow	2 liters/minutes minimum.
冷却水圧力損失	Water Pressure Loss	0.06Kg/(cm*cm)
冷却水温度上昇	Water Temperature Rise	1.4 °C
ケース温度上昇	Case Temperature Rise	14 °C
抵抗面温度上昇	Surface Temperature Rise	50 °C
抵抗面最高温度	Surface Temperature Rise	Maximum 110 °C
定格電力	Rating Power	500W (250W/resistor element)
最高使用電力	Max. Applied Power	700W (350W/resistor element)
最大連続インパルス	Max. Continuous Impulse Load	Peak Power 37KW/10us/10KHz (Only for reference)
破壊点インパルス	Damaged Impulse Load	100KW peak power/70us single and 37KW peak power/34us continuous.
端子線	Terminal Codes	Teflon Insulated Wire (0.18/30, outer diameter 2mm, Blue), 200mm length.
耐電圧	Dielectric Strength	AC2000V, 60 seconds. (Between terminals and case)
最高使用電圧	Max Operating Voltage	AC1000V
絶縁抵抗	Insulation Resistance	1000MΩminimum. (Between terminals and case)
負荷寿命	Load Life	+/-2% (Rating 500W, 1000 hours)
耐湿性	Humidity	+/-2%(Rating*0.1, 1000hours, continuous load)
重量	Weight	350 grams

### 形名称呼・ Ordering Information

Model	TCR	Resistance	Tolerance	Remarks
RPH500	H	20 Ohm	K	
RPH500	H (250ppm/K)	0.1 Ohm-1k Ohm	K (+/-10%)	
RPH500-000				
RPH500-001				
RPH500-999				

xxx: 3 digits specified code from specification draw, please call factory

### 端子接続 Schematics & Wiring

1個の抵抗器、RPH500には、通常、2個の抵抗素子を取り付けてあり、抵抗器内部の接続方法は、[直列] [並列] [独立]の3種類が可能です。標準の接続方法は直列です。形名称呼にて、20 Ohmと指定すれば、直列接続で、20 Ohmになった製品をお届けいたします。リード線長さ、端子接続方法をご指定なされる場合は、工場に連絡ください。

A resistor includes a couple of resistor elements and has following three ways connection. Series connection is standard, but if customer request specified connection and fly-lead length, please call our factory.

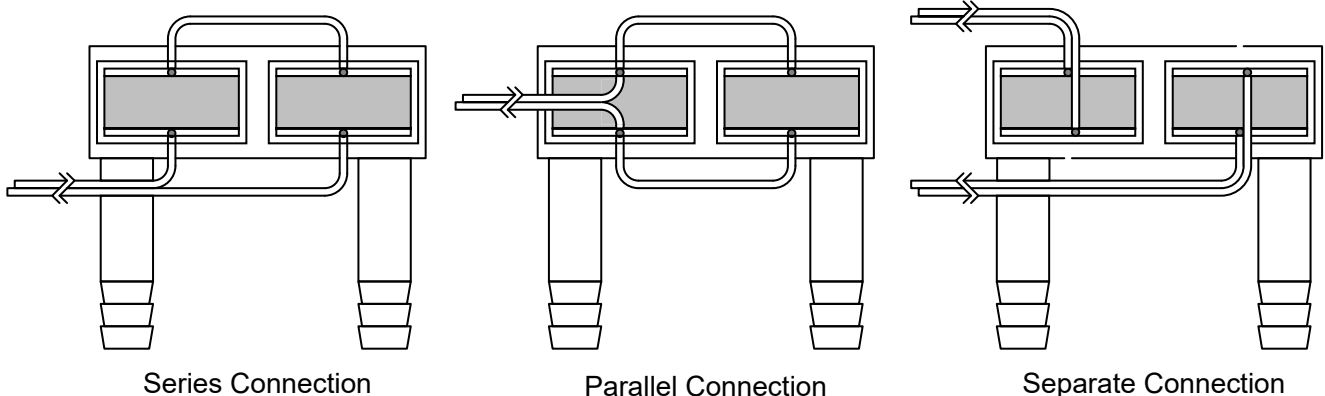

500W 水冷高電力抵抗器

500W WATER COOL NON-INDUCTIVE HIGH POWER RESISTORS

RPH500

温度上昇・Temperature Rise Characteristics

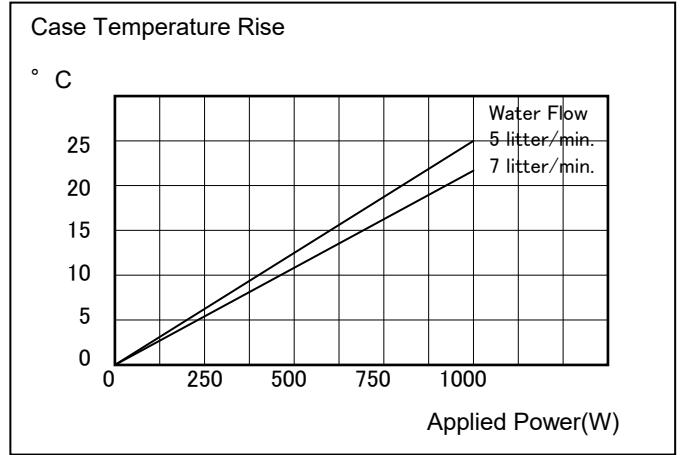
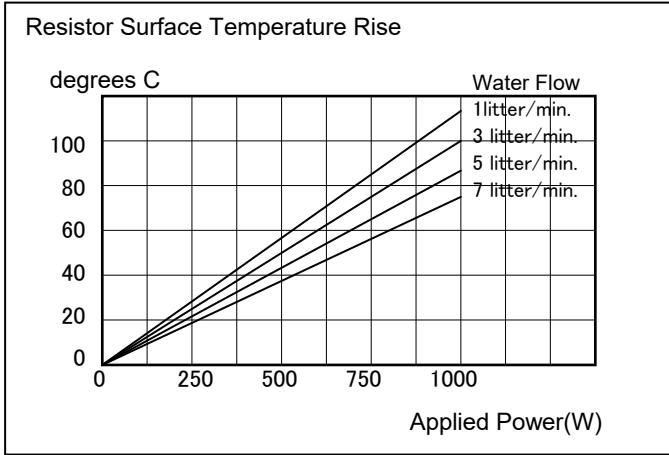

RPH500 の推奨動作状態 Recommended Long Life Actual Application of RPH500 snubber.

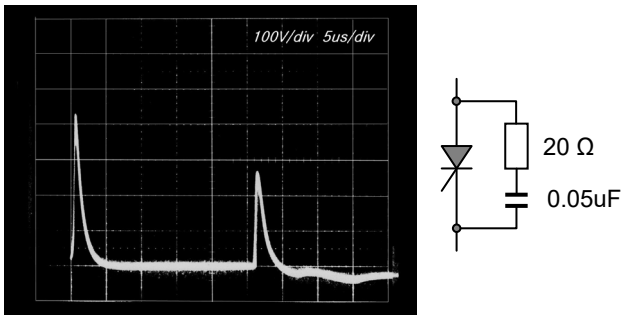

サイリスタコンバータ CR スナバ抵抗

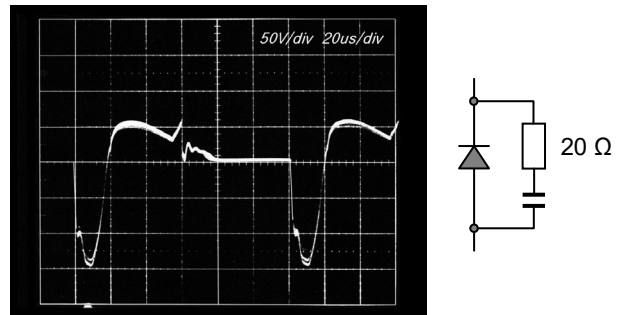

CRD スナバ抵抗

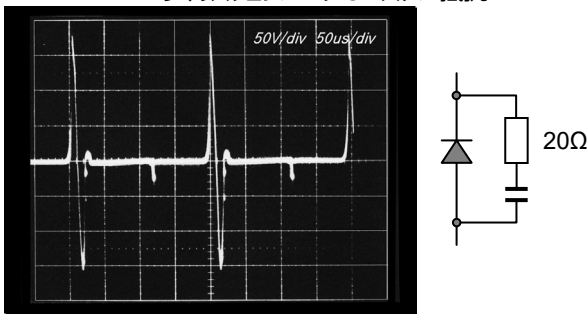

CRD スナバ抵抗

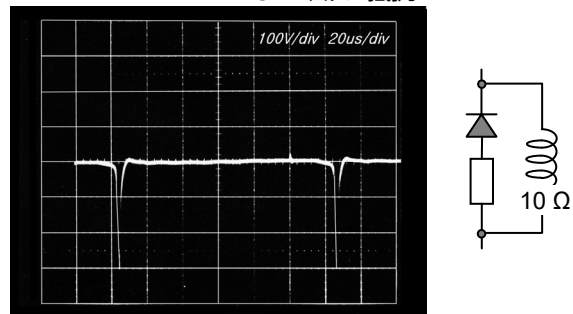

LRD スナバ抵抗

