

マイクロ波ターミネーション RFT

10W, 50W, 80W, 100W, 150W, 200W, 250W
FLANGED POWER TERMINATIONS, RFT

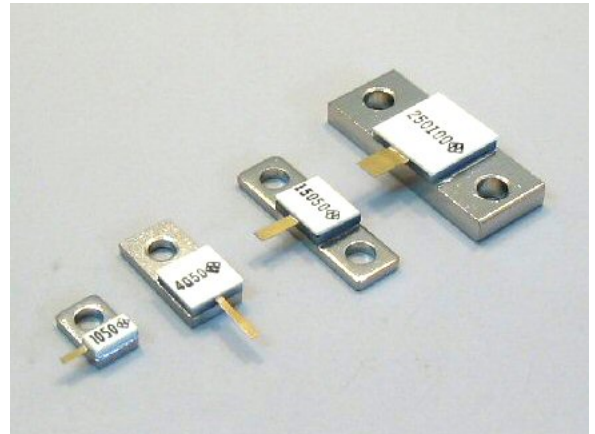

特長用途

DC-4GHz、10W-600W フランジターミネーション。
高熱伝導の窒化アルミ基板を使用した小型、広帯域ターミネーション。
スパッタ薄膜テクノロジーによる機械的強度に優れたターミネーション。公称特性インピーダンスは 50ohm、DC 抵抗値許容差は±1%。
多様な寸法、裏の放熱電極構造、1 個ないし 2 個にてねじ止めするフランジ型を標準化。
抵抗膜は Ni-Cr 合金であり長期間の耐久性、優れた周囲温度依存性を発揮。
アイソレータ、サーキュレータ、基地局送信機、高出力高周波電源装置、高出力マイクロ波電力増幅器など。

Features and Applications

High power flanged termination for all DC up to 4GHz applications.
Small size and wide frequency range specifications realized with through large heat conducting AlN substrate.
Sufficient mechanical strength metallization from sputtered thin film technology.
50ohm resistance with tolerance 1%, and terminations include chips and many style flange provided as standard, and other resistance and power available.
Long life and temperature stability are shown by a result of Ni-Cr thin film technology.
Applications include Termination for isolator/circulators, base station of mobile communication electronics, High power microwave amplifiers

品目番号 Ordering Information

ビームリード長さ 5mm 5.0 mm beam lead length

Type	Style	TCR	Resistance	Tolerance	RoHS/Package	Tray
RFT050	120	C	500	F	Z05	Tray
RFT010	100	C	50 Ohm	F	Z05	PE トレイ
RFT050	110	(50ppm)		(1.0%)		
RFT080	120					
RFT100	130					
RFT150	140					
RFT200						
RFT250						

ビームリード長さ 10mm 10mm beam lead length

Type	Style	TCR	Resistance	Tolerance	RoHS/Package	Tray
RFT050	121	C	500	F	Z00	Tray
RFT010	101	C	50 Ohm	F	Z00	PE トレイ
RFT050	111	(50ppm)		(1.0%)		
RFT080	121					
RFT100	131					
RFT150	141					
RFT200						
RFT250						

10W, 50W, 80W, 100W, 150W, 200W, 250W, TERMINATIONS, Type RFT

外形寸法(mm)

Style and Dimensions (mm)

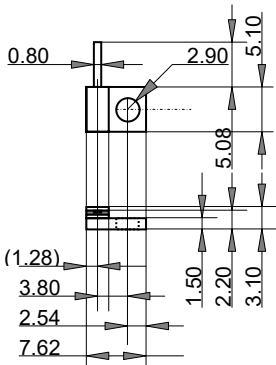

RFT010 120

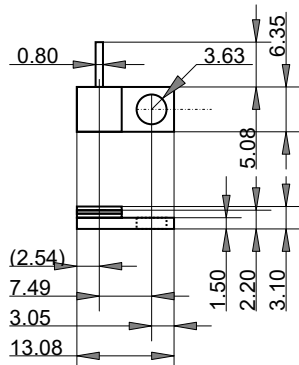

RFT050 120
RFT080 120

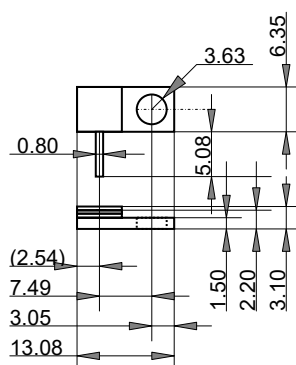

RFT050 130
RFT080 130

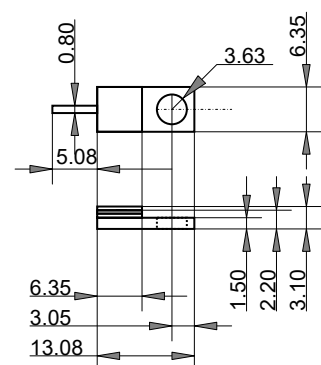

RFT050 140
RFT080 140

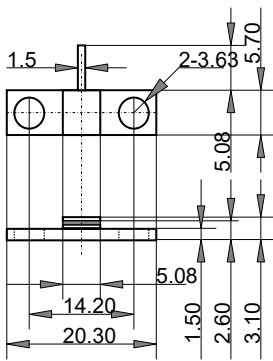

RFT050 110

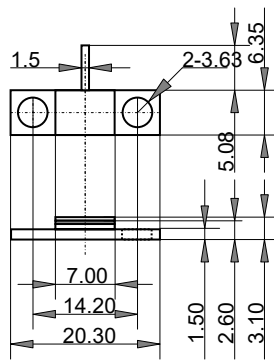

RFT100 110

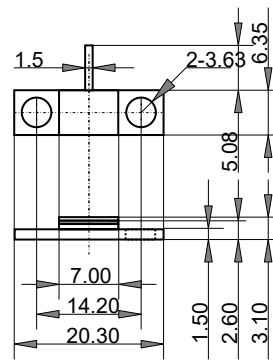

RFT150 110

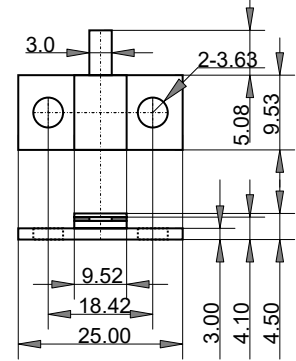

RFT250 110

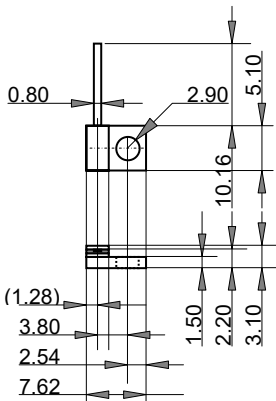

RFT010 121

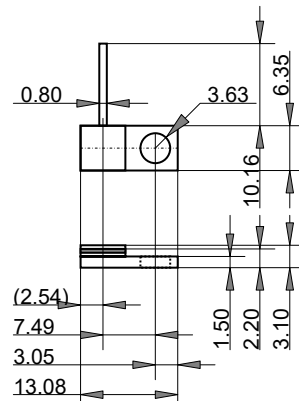

RFT050 121
RFT080 121

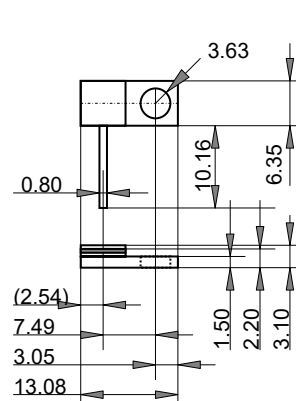

RFT050 131
RFT080 131

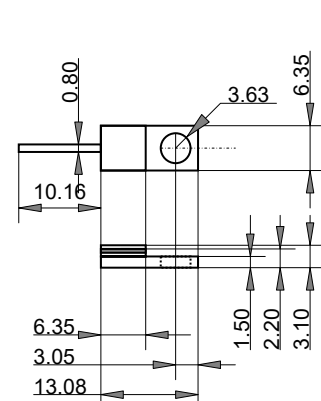

RFT050 141
RFT080 141

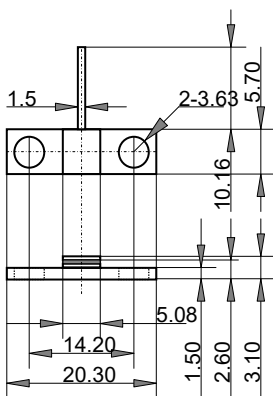

RFT050 111

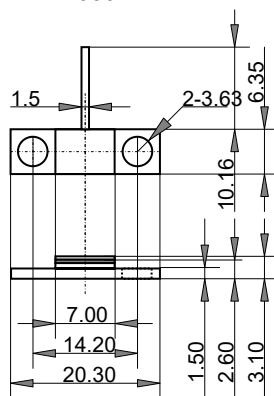

RFT100 111

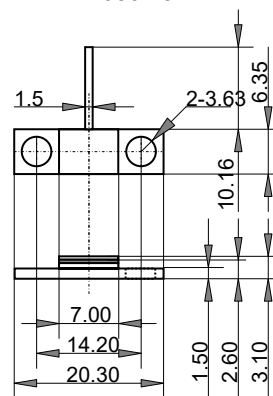

RFT150 111

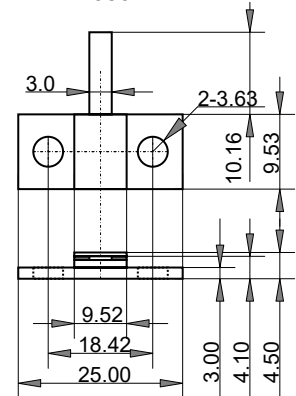

RFT250 111

10W, 50W, 80W, 100W, 150W, 200W、250W, TERMINATIONS, Type RFT

高周波特性

Performance Specifications

Type	Rated Power (W)	Heat Resistance (°C/W)	VSWR 500MHz	VSWR 1GHz	VSWR 2GHz
RFT010	10	6.5	---	1.15	---
RFT050	50	2.5	---	1.15	---
RFT080	80		---	1.20	---
RFT100	100	1.3	---	1.20	---
RFT150	150		---	1.30	---
RFT200	200		---	1.30	---
RFT250	250	0.5	---	1.30	---

材質

Materials

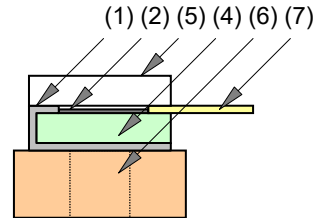

	Substance	Material
(1)	Cold end Terminal	Tin plated Ni-Cu
(2)	Resistive	Ni-Cr
(3)	Substrate	ALN
(4)	Hot end Terminal	Tin plated Ni-Cu
(5)	Cover	ALO
(6)	Flange	Ni plated Cu
(7)	Beam Lead	Au plated Cu

負荷軽減

Derating

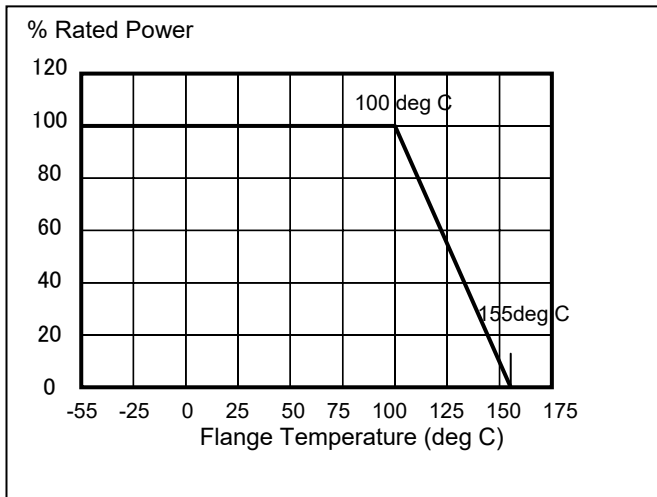

Return Loss, VSW

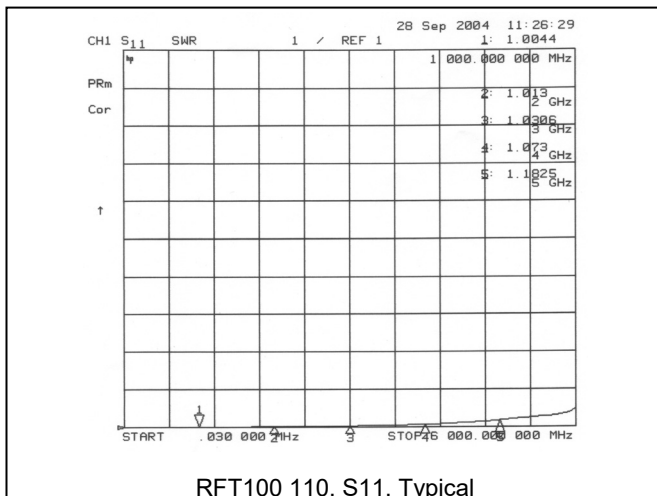

Return Loss, VSW

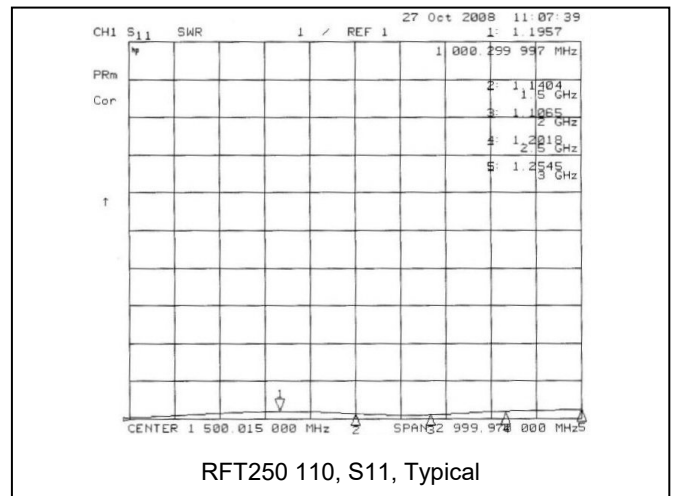

Note: RoHS 2011/65/EU 適合 conformity.
 生産地: 青森県三沢市 Country origin, Aomori Pref. Japan