

TO220 50W HIGH POWER RESISTORS

RNP-50U

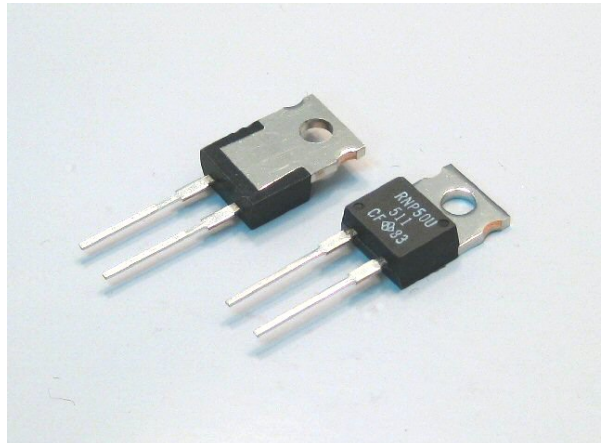

特長用途

TO220 パッケージの、定格電力 50 W高電力抵抗器。リード付高電力抵抗器。最大カテゴリ温度 175°C。AEC-Q200 試験済み。
 無誘導抵抗体で、高周波回路、高速パルス回路に最適。
 抵抗からフランジまでの熱抵抗は、TO220 で世界最小の 2.3°C/Wを達成。薄膜テクノロジーを駆使したフランジ接合を採用し信頼性を向上。
 抵抗値は、0.02Ωから 51kΩと広範囲、完全な放熱設計が可能で、機器の小型化、耐振性向上にとって最適な電力用抵抗器。
 電源装置、モータ駆動機器、インバータ、高周波電源装置、電子負荷装置、自動車電装機器、工業計器などの高調波フィルタ抵抗、ブロード抵抗、スナバ抵抗、ダンピング抵抗、ゲート駆動抵抗として適しています。

Features and Applications

50W high power resistors in TO220 style mold package for through-hole and screw mounting.
 AEC-Q200 test certified.
 Non-inductive design suits high frequency applications and high-speed pulse circuits.
 Low, 2.3 °C/W heat resistance from resistor hot spot to flange and long life performance are presented with thin film metallization technology and rejection of plastic adhesive joint.
 Wide 20 milliohm to 510kohm wide resistance range, non-inductive impedance characteristic and heat conduction through the insulated metal flange aids circuit designers.
 Small size and thin profile suit high-density compact installations.
 Complete thermal conduction, heat dissipation design and vibration durable design also available.
 Applications for harmonic filter, bleeder, snubber, gate, dumping, current sensing for UPS, power electronics, motor control, drive circuits, automotive electronics, measurements, industrial computers and high frequency electronics.

外形寸法 Dimensional Specifications (mm)

構造材料 Structure and Material

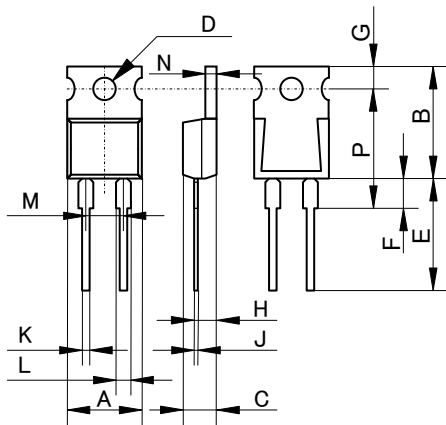

RNP-50U	
mm	+/-mm
A	10.1 +/-0.2
B	15.0 +/-0.2
C	4.5 +/-0.2
D	3.6 +/-0.1
E	15.5 +/-1.0
F	4.0 +/-0.5
G	3.0 +/-0.2
H	2.75 +/-0.2
J	0.5 +/-0.05
K	0.75 +/-0.05
L	1.5 +/-0.05
M	5.08 +/-0.10
N	1.5 +/-0.05
P	16.0 +/-0.50

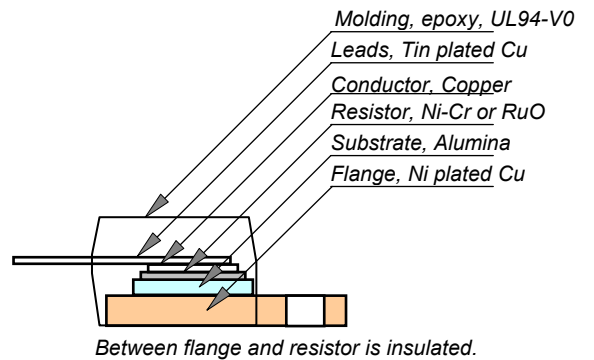

形名称 Ordering Information

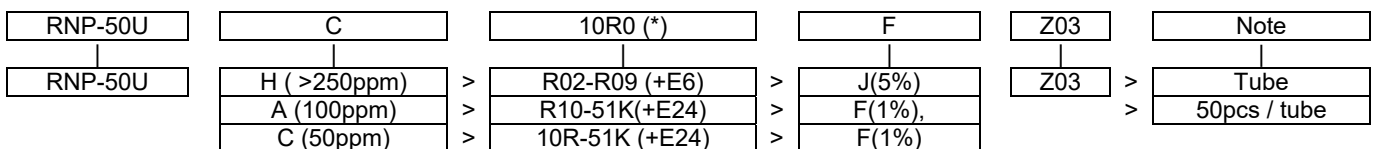

Resistance value (*) is available following modified E24, +E24.

1.0	1.1	1.2	1.3	1.5	1.6	1.8	2.0	2.2	2.4	2.5	2.7	3.0	3.3
3.6	3.9	4.0	4.3	4.7	5.0	5.1	5.6	6.2	6.8	7.5	8.0	8.2	9.1

Note*: When ordering, additional ohm resistance notation recommends for keeping out of misunderstanding.

TO220 50W HIGH POWER RESISTORS

RNP-50U

Specifications

		RNP-50U			Test Conditions
定格電力	Rated Power	50 W			-55 °C to 25 °C flange temperature
定格電力	Rating Power	1 W			Free air.
熱抵抗	Heat Resistance	2.3 °C/W			Resistor to flange
抵抗値範囲	Resistance Range	0.02-0.09ohm	0.1-9.1 ohm	10-51Kohm	Note 2
公称抵抗値	Nominal Resistance	E6	E24+	E24+	Include 2.5, 4.0, 5.0, 8.0 and 16
抵抗温度係数	TCR, ppm/°C	>250 (H)	100 (A)	50 (C)	Note 3
抵抗値許容差	Tolerance	5%(J)	1% (F), 5% (J)	+/-1% (F)	
抵抗体材料	Materials	厚膜		薄膜	
等価静電容量	Capacitance	1.69pF			Equivalent parallel capacitance.
インダクタンス	Inductance	9.65nH			Equivalent series inductance
動作温度範囲	Operation Temp.	-55 °C to +175 °C			
最高使用電圧	Max. Operating Volt.	smaller either 700V or $\sqrt{P \times R}$			P is rating power and R resistance
絶縁耐電圧	Withstanding Voltage	2000VAC			Terminal and flange, 60 seconds, 1mA
定格負荷寿命	Load Life	+/- 1.0 %			25 °C, 90 min. ON, 30 min. OFF, 1000 hours.
耐湿性	Humidity	+/- 1.0 %			40 °C, 90-95%RH, DC 0.1W, 1000 hours.
温度サイクル	Temp. Cycle	+/- 0.25 %			-55 °C, 30 min., +155 °C, 30 min., 5cycles
はんだ耐熱性	Soldering Heat	+/- 0.1 %			350+/-5 °C, 3seconds,
はんだ付け性	Solder ability	Over 95% of surface			245+/-5 °C, 3seconds.
絶縁抵抗	Insulation Resistance	Over 1,000 MΩ			Between terminals and flange.
耐振性	Vibration	+/- 0.25 %			IEC60068-2-6, see note 4
難燃性	Weight	2.1 grams			

負荷軽減曲線 Derating

Rating Power (W)

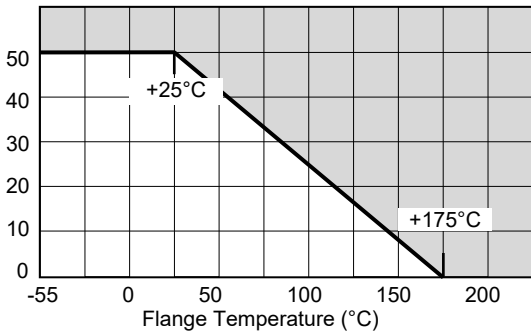

温度上昇 Temperature Rise

Temperature Rise (°C)

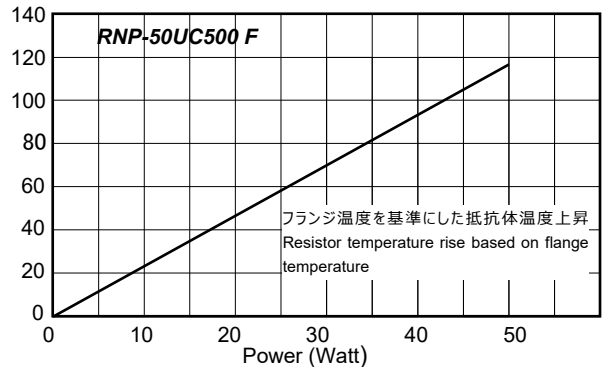

パルス許容電力

Pulse peak power (W)

Applied to RNP-50UC10hmF and resistance < 100ohm

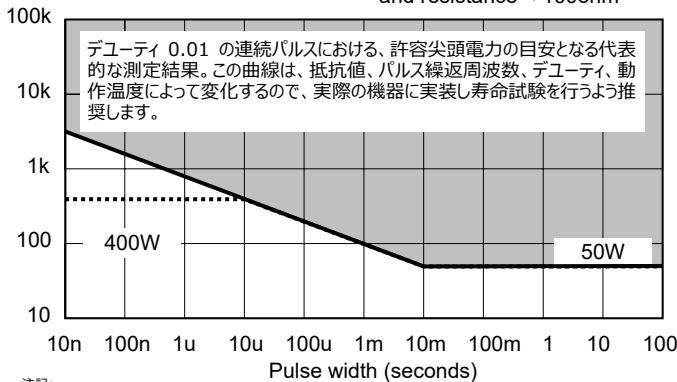

注記:

- (1) フランジとヒートシンク間の熱伝導絶縁シートはいりません。フランジは抵抗器内部の抵抗素子から絶縁されています。
- (2) 抵抗値は、抵抗モールドの下面から 5.27mm +/-0.6 mm の位置で定義します。
- (3) 低抵抗値の抵抗器の TCR は、銅リードの抵抗温度係数に依存します。TCR は次の値を示します。 300ppm/0.02ohm, 200ppm/0.05ohm, 140ppm/0.1ohm and 80ppm/0.2ohm.
- (4) 耐振性能は、IEC60068-2-6 の試験方法によります。試験方法は、掃引正弦波波形、100Hz-2000Hz, 10 cycles, 振幅 0.75mm or 100m/s², 90minutes. x-y z 方向です。
- (5) 抵抗器をヒートシンクに、ねじ、クリップ、押さえ金属帯で取り付ける場合は、フランジとヒートシンクの間に熱伝導グリスを少量塗布してください。ねじ止めする場合は推奨締付トルクは 0.5-0.6Nm としてください。
- (6) 標準的な包装は、静電気防止 PE チューブを使用します。包装数量は、100pcs / チューブです。

周波数特性 Frequency Characteristics

Impedance (ohm)

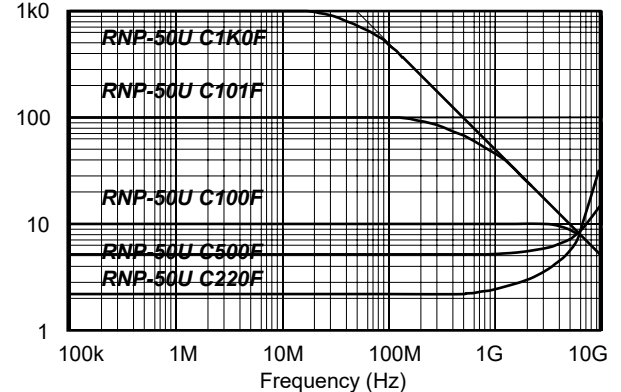

Note:

- (1) Insulation material is unnecessary between flange and heat-sink, flange and resistor is separated by alumina substrate.
- (2) Resistance measurement shall be made at a point 5.27mm +/-0.6 mm from the resistor body.
- (3) TCR of low resistance will be increased as 300ppm/0.02ohm, 200ppm/0.05ohm, 140ppm/0.1ohm and 80ppm/0.2ohm typically. Testing point is at 5.27mm from bottom of molding of terminals.
- (4) Test method is IEC60068-2-6, and specification is sine sweep wave form, 100Hz-2000Hz, 10 cycles, amplitude 0.75mm or 100m/s², 90minutes. direction x-y z. Amplitude 0.75mm will be applied under break point Frequency (about 60Hz) and 100m/s² over break point
- (5) When mounting resistor on heat-sink by screw, clip and pressure strip with using heat conduction grease on back side of resistor are recommended. Recommended screw torque is 0.5-0.6Nm.
- (6) Standard packaging is anti-static PE tray, which contains 100pcs / tray.

20200601