

# 50W TO263 HIGH POWER RESISTORS

(D2PAK)

RNP-50E

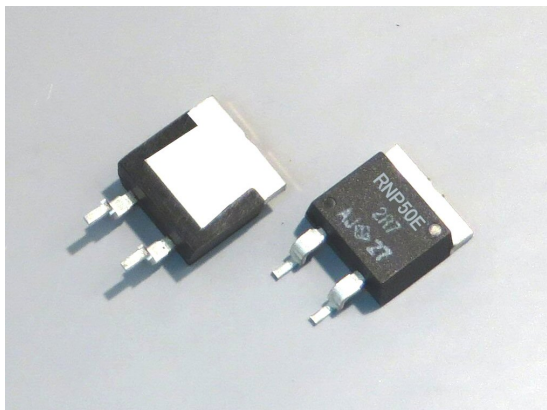

## 特長用途

TO263 (D2PAK)パッケージの、定格電力 50W 高電力抵抗器。表面実装高電力抵抗器。最大カテゴリ温度 175°C、AEC-Q200 試験済み。無誘導抵抗体で、高周波回路、高速パルス回路に最適。抵抗からフランジまでの熱抵抗は、TO263 で世界最小の 2.3°C/W を達成。薄膜テクノロジーを駆使したフランジ接合を採用し信頼性を向上。抵抗値は、0.02Ω から 510kΩ と広範囲、完全な放熱設計が可能で、機器の小型化、耐振性向上にとって最適な電力用抵抗器。電源装置、モータ駆動機器、インバータ、高周波電源装置、電子負荷装置、自動車電装機器、工業計器などの高調波フィルタ抵抗、ブリーダ抵抗、スナバ抵抗、ダンピング抵抗、ゲート駆動抵抗として適しています。

## Features and Applications

TO263 (D2PAK) 50W surface mount high power resistors. Non-inductive design suits for automotive electronics, high frequency applications and high-speed pulse circuits. Thin film metalize technology presents lowest 2.3 °C/W heat resistance from resistor to flange. Wide, 20mΩ to 510kΩ resistance range, non-inductive impedance characteristic and heat venting through insulated metal flange aids circuit designers. Small size and thin profile suits for high-density compact installations. Complete thermal conduction, heat dissipation design and vibration durable design to be easy. Applications for harmonic filter, bleeder, snubber, gate, dumping, current sensing for UPS, power electronics, motor control, drive circuits, automotive electronics, measurements, industrial computers and high frequency electronics.

## 外形寸法 Dimensional Specifications (mm)

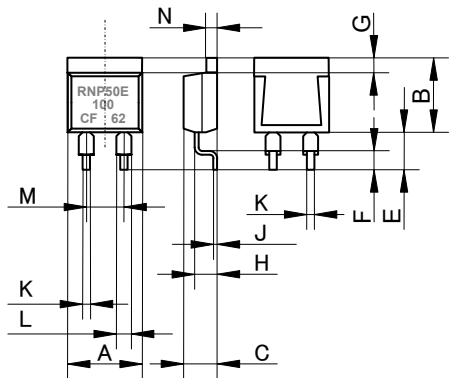

RNP-20E		
	mm	+/-mm
A	10.1	+/-0.2
B	10.3	+/-0.2
C	4.5	+/-0.2
D	-	-
E	5.0	+/-1.0
F	2.5	+/-0.5
G	2.2	+/-0.2
H	2.75	+/-0.2
J	0.5	+/-0.05
K	0.75	+/-0.05
L	1.5	+/-0.05
M	5.08	+/-0.10
N	1.5	+/-0.05

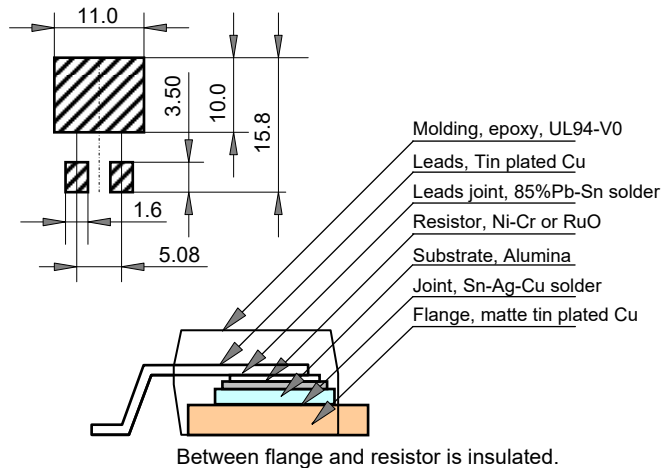

## 形名呼称 Ordering Information

RNP-50E	C	10R0 (*)	F	Z01	Note Tape & reel 50pcs / tube
RNP-50E	H (>250ppm)	R02-R09 (+E6)	J(5%)	Z01	
	A (100ppm)	R10-9R1(+E24)	F(1%), J(5%)	Z03	
	C (50ppm)	10R-51K (+E24)	F(1%)		

Resistance value (\*) is available following modified E24, +E24.

1.0	1.1	1.2	1.3	1.5	1.6	1.8	2.0	2.2	2.4	2.5	2.7	3.0	3.3
3.6	3.9	4.0	4.3	4.7	5.0	5.1	5.6	6.2	6.8	7.5	8.0	8.2	9.1

Note\*: When ordering, additional ohm resistance notation is recommended for keeping out of misunderstanding.

Note:

- Resistance measurement shall be made at a point 5.27mm +/-0.6 mm from the resistor body.
- TCR of low resistance will be increased as 300ppm/0.02Ω, 200ppm/0.05Ω, 140ppm/0.1Ω and 80ppm/0.2Ω typically. Testing point is at 5.27mm from bottom of molding of terminals.
- Test method is IEC60068-2-6, and specification is sine sweep wave form, 100Hz-2000Hz, 10 cycles, amplitude 0.75mm or 100m/s<sup>2</sup>, 90minutes. direction x-y-z. Amplitude 0.75mm will be applied under break point Frequency (about 60Hz) and 100m/s<sup>2</sup> over break point
- Standard packaging is anti-static PE tape and reel, reel contains 500pcs/reel.

50W TO263 (D2PAK) HIGH POWER RESISTORS

RNP-50E

Specifications

定格電力	Rated Power	50 Watt			-55 °C to 25 °C flange temperature
定格電力	Rating Power	1 Watt			Free air.
熱抵抗	Heat Resistance	2.3 °C/W			Hot spot to flange
抵抗値範囲	Resistance Range	0.02-0.091Ω	0.1-9.1 ohm	10-51KΩ	
公称抵抗値	Nominal Resistance	E6	E24+	E24	Include 2.5, 4.0, 5.0, 8.0 and 16
抵抗温度係数	TCR (ppm/deg C)	250(H)	100 (A)	50 (C)	-55 °C to +155 °C
抵抗値許容差	Tolerance	5%(J)	1% (F), 5% (J)	+/-1% (F)	Note 2
等価静電容量	Capacitance	1.69pF			Equivalent parallel capacitance.
インダクタンス	Inductance	9.65nH			Equivalent series inductance
動作温度範囲	Operation Temp. Range	-55°C to +175 °C			
最高使用電圧	Max. Operating Volt.	Small value either 700V or $\sqrt{P \times R}$			P is rating power and R resistance
絶縁耐電圧	Withstanding Voltage	2000 VAC			60 seconds. 1mA
定格負荷寿命	Load Life	+/- 1.0 %			25 °C, 90 min. ON, 30 min .OFF, 1000 h.
耐湿性	Humidity	+/- 1.0 %			40 °C, 90-95%RH, DC 0.1W, 1000 h.
温度サイクル	Temp. Cycle	+/- 0.25 %			-55 °C,30min.,+155°C,30min., 5cycles
はんだ耐熱性	Soldering Heat	+/- 0.1 %			350+/-5 °C, 3seconds,
はんだ付け性	Solder ability	Over 95% of surface			230+/-5 °C, 3seconds.
絶縁抵抗	Insulation Resistance	Over 1,000 Meg Ω			Between terminals and flange.
耐振性	Vibration	+/- 0.25 %			IEC60068-2-6, see note 4
難燃性	Flammability	UL94V-0			
重量	Weight	1.5 grams			

負荷軽減曲線 Derating

Rating Power (W)

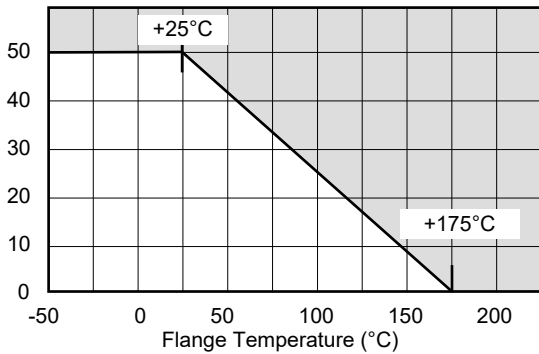

温度上昇 Temperature Rise

Temperature Rise (°C)

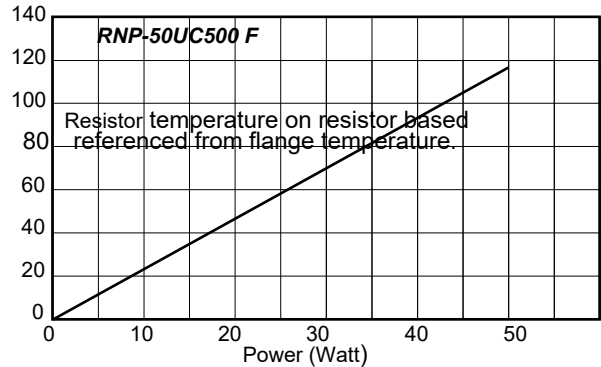

パルス許容電力 Pulse Durability

Pulse Peak Power(W)

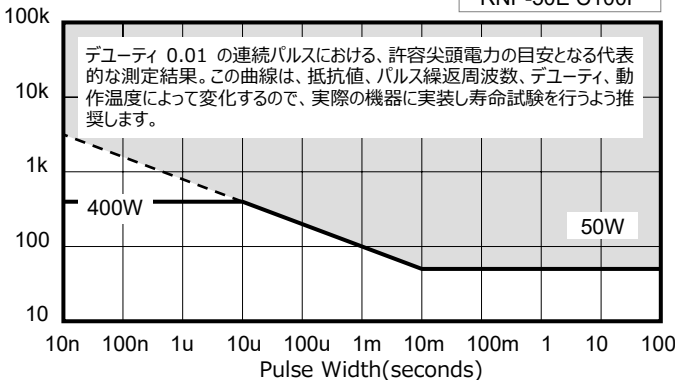

周波数特性 Frequency Characteristics

Impedance (Ω)

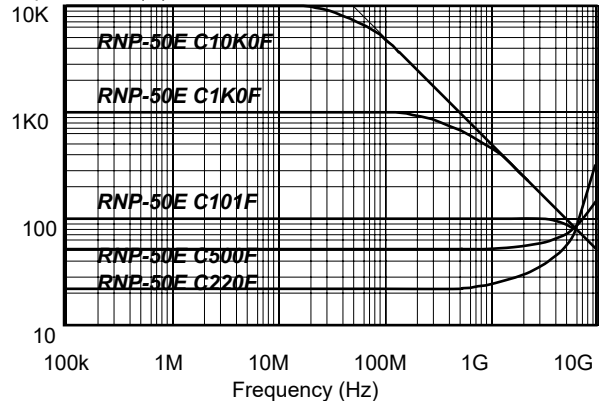

注記:

- (1) フランジとヒートシンク間の熱伝導絶縁シートは有りません。フランジは抵抗器内部の抵抗素子から絶縁されています。
- (2) 抵抗値は、抵抗モールドの下面から 5.27mm +/-0.6 mm の位置で定義します。
- (3) 低抵抗値の抵抗器の TCR は、銅リードの抵抗温度係数に依存します。TCR は次の値を示します。300ppm/0.02ohm, 200ppm/0.05ohm, 140ppm/0.1ohm and 80ppm/0.2ohm.
- (4) 耐振性能は、IEC60068-2-6 の試験方法によります。試験方法は、掃引正弦波波形、100Hz-2000Hz, 10 cycles, 振幅 0.75mm or 100m/s<sup>2</sup>, 90minutes. x-y z 方向です。
- (5) 標準的な包装は、静電気防止エンボステープ PE を使用します。包装数量は、500pcs / テープリールです。

Note:

- (1) Resistance measurement shall be made at a point 5.27mm +/-0.6 mm from the resistor body.
- (2) TCR of low resistance will be increased as 300ppm/0.02Ω, 200ppm/0.05Ω, 140ppm/0.1Ω and 80ppm/0.2Ω typically. Testing point is at 5.27mm from bottom of molding of terminals.
- (3) Test method is IEC60068-2-6, and specification is sine sweep wave form, 100Hz-2000Hz, 10 cycles, amplitude 0.75mm or 100m/s<sup>2</sup>, 90minutes. direction x-y z. Amplitude 0.75mm will be applied under break point Frequency (about 60Hz) and 100m/s<sup>2</sup> over break point
- (4) Standard packaging is anti-static PE tape and reel, reel contains 500pcs/reel.

20181101