

600W
SOT220 高電力抵抗器
CHASSIS MOUNTING NON-INDUCTIVE
HIGH POWER RESISTORS
RPM550, RPM600



特長・用途

空冷放熱器あるいは液冷放熱体に取り付けて動作させる小型・軽量、SOT227パッケージの 600W 高電力抵抗器。
内部は絶縁樹脂を完全充填し端子と放熱器間の耐電圧と部分放電を保障し、長期安定性を発揮する。
標準は2.5kVの絶縁耐電圧、オプションで4kVの絶縁耐電圧保障。6種類の複合回路を実装でき、設計の際の柔軟性を発揮できる。
等価直列インダクタンス、等価並列キャパシタンスを削減し、広帯域動作が可能。
車載電子機器、パワーエレクトロニクス機器、ME 機器、PA システムなどの、スナバ抵抗、フィルタ抵抗、ブリーダ抵抗、分圧抵抗など性能を発揮します。

Features and Applications

Small size SOT227, light weight, 600W high power resistor install on air-cooled heat sink or water-cooling is necessary.
New ceramics substrate shown highest heat conduction play small size high power resistor.
Completely resin filled structure provides high insulation voltage between heat-sink / resistor and partial discharge performance, long-life stable operation.
2.5kV insulation voltage is standard and 4.0kV insulation is available in option.
Various 6 types of circuit configuration gives ease customer's applications.
Very low series inductance and parallel capacitance make wide frequency range operation.
Applications include snubber resistors, filter resistors, bleeder resistor, current detect for automotive electronics and many types of power electronics as UPS, power supply, professional audio.

外形寸法 Dimensions

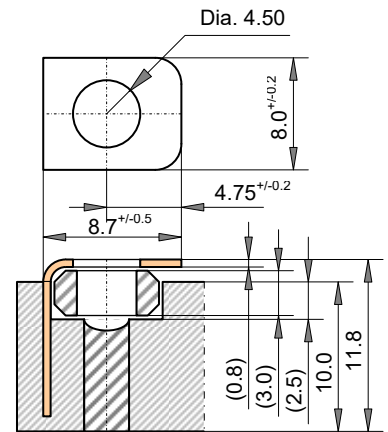
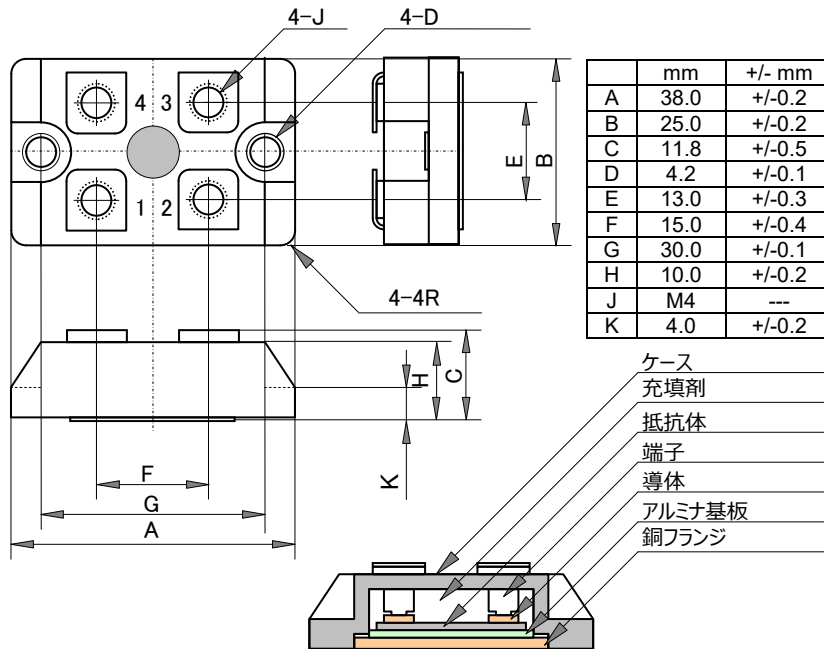

端子ネジ (M4/6mm) は付属しています

Note: 端子ねじの入る深さは約 4.3mm です。The depth of the screw hole is about 4.3mm from the surface of the terminal plate.

端子接続 Schematics

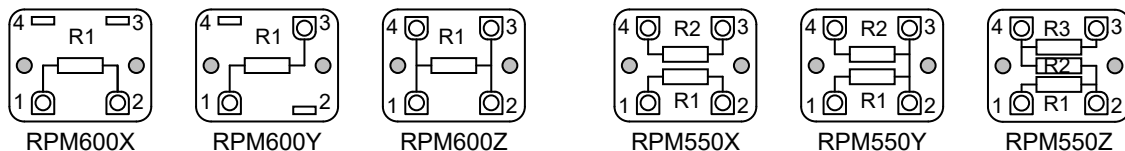

600W 高電力抵抗器

RPM550, RPM600

CHASSIS MOUNTING NON-INDUCTIVE HIGH POWER RESISTORS

品目番号 Ordering Information

形式 Type RPM600	端子 Terminal Connection Z	温度係数 TCR	抵抗値 Resistance 101 (*)	許容差 Tolerance J	追加記号 RoHS Z00
RPM550	X Y Z	100ppm/°C	+E12 R1=R2=R3	J (5%)	Z00 (RoHS)

(*) 2素子実装の抵抗器の場合の品目番号は RPM150X101JZ00 のようになります。 When a network circuit configuration contains two resistors, ordering is RPM150X101JZ00.
 (***) 端子ねじは品目番号に(S)を付けたと、ねじ M4-5mmL が付属します。 Terminal screws provide by showing screw option 'S' in ordering information, M4-5mmL only.
 (***) 4KV 絶縁耐電圧仕様を指定する場合は、RPM200X4KV101JZ00 のように記載してください。 When ordering of the option 4KV insulation, please specify P/N as RPM200X4KV 101JZ00.

性能仕様 Specifications and Performances

		RPM550	RPM600	Conditions
定格電力	Rating Power	600 Watts	600 Watts	At flange temp. -55°C to +25°C
端子接続	Configuration	XYZ	XYZ	
熱抵抗	Thermal Resist.	0.11 °C /W	0.11 °C /W	
内蔵抵抗素子	Single or Dual	More than one		Same resistance, R1= R2= R3
抵抗値範囲	Resistance Range	50Ω to 1kΩ		
抵抗値	Resistance	E12+		Additionally, 2.5 and 5.0.
抵抗温度係数	TCR	+/-100 ppm/°C		For -55°C to +120°C
抵抗値許容差	Tolerance	+/-5% (J)		1% optional
抵抗素子温度範囲	Operation Temp.	-55°C - +155 °C		At resistor surface
最大端子間電圧	Max. Voltage	Less than $E = \sqrt{P \cdot R}$ or 1000V		
最大電流	Max. Current	100A		
絶縁耐電圧	Withstanding	2500 VAC		60 seconds-1mA. 4KVAC optionally available
端子間容量	Capacitance between terminals	13.1pF		
端子間インダクタンス	Inductance	13.7nH		
負荷寿命	Load Life	+/-1.0 %		25°C, 90 min. ON, 30min.OFF, 1000h.
耐湿性	Humidity	+/-1.0 %		40°C, 90 to 95%RH, DC0.1W, 1000h.
温度サイクル	Temp Cycle	+/-1.0 %		Note 1
短時間過負荷	Short Time OL	Rated power		Note 2
絶縁抵抗	Insulation	Over 1000 MΩ		Between terminals and flange.
耐振性	Vibration	+/-0.25 %		Note 4
難燃性	Flammability	UL94V-0		
重量	Weight			

Note1: 温度サイクル試験は、-55°C, 30 min., +120°C 30min., 20 cycles です。
 Note2: 数秒にわたる短時間過負荷を印加しないでください。 Several seconds overload can not be applied.
 Note3: 端子のねじのトルクは、1N/m 推奨 0.6N/m, 抵抗器の取付は 1N/m. Torque: Terminal 1.0Nm max, 0.6Nm recommend. Mounting 1.6Nm max, 1.0Nm recommend.
 Note 4: 振動試験の規格は、次の通りです。 IEC60068-2-6, displacement 0.75mm or acceleration 100m/sec², 10Hz-54Hz sweep, 10 cycles X-Y-Z direction.

